

Unit Overview: Geometry – Year 1

National Curriculum Requirements

By the end of the year, the children will be able to:

Properties of shapes

- recognise and name common 2-D and 3-D shapes, including:
 - 2-D shapes, e.g., rectangles (including squares), circles and triangles
 - 3-D shapes, e.g., cuboids (including cubes), pyramids and spheres

Position and direction

- describe position, direction and movement, including whole, half, quarter and three-quarter turns

Vocabulary

- shape
- 2D / 3D
- straight line / curved line
- corner
- side
- rectangle
- square
- circle / semi-circle
- triangle
- edge
- face
- point
- forwards / backwards
- turn

Manipulatives

- pictures of 2-D shapes
- 3-D shapes

Visual Representations

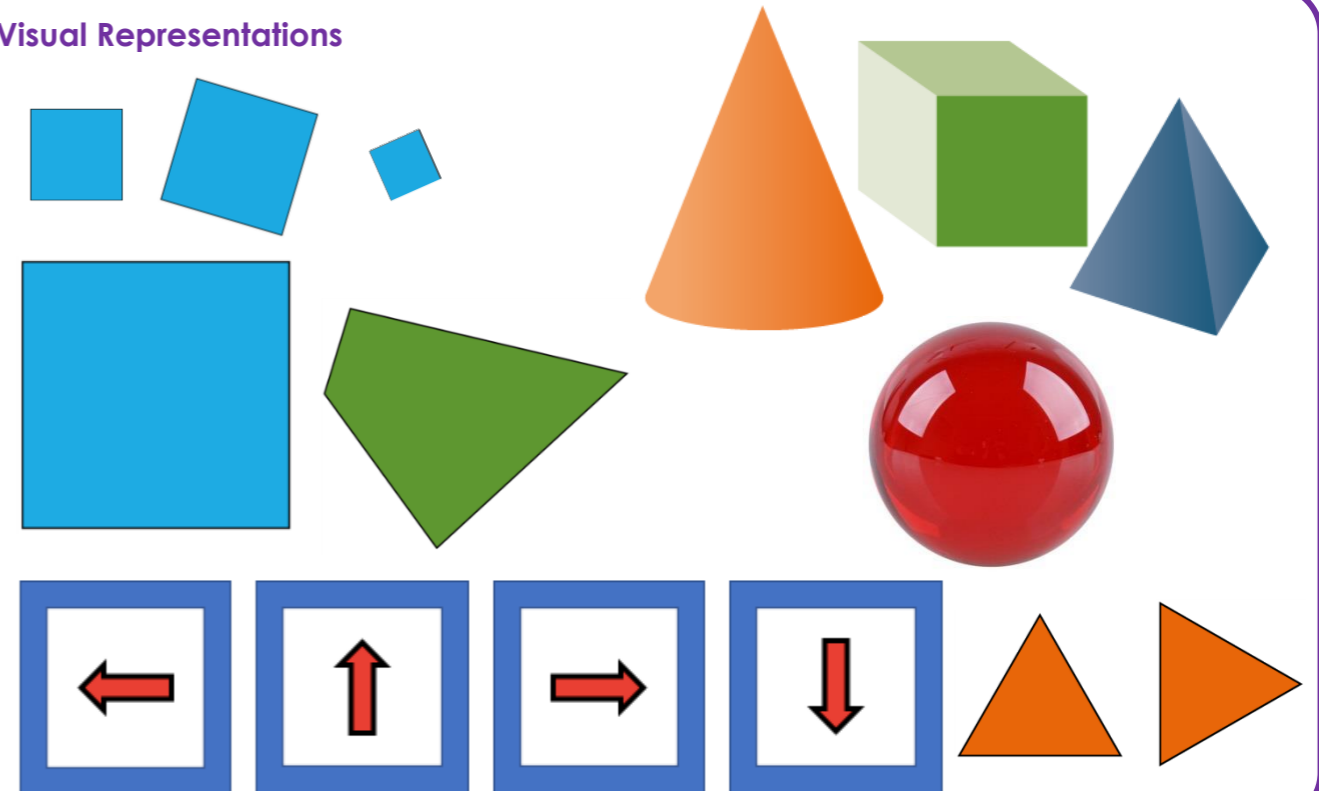

Sentence Stems

This is a __D shape.

This shape has ____ corners.

This shape has ____ sides.

This shape is called a _____.

The _____ is _____ item in the group.

The _____ is _____ the _____.

Move ____ steps _____.

Turn _____ by a _____ turn.

This is a __D shape.

This shape has ____ corners.

This shape has ____ edges.

This shape has ____ faces.

This shape is called a _____.

Learning Sequence

- describe 2D shapes (referring to sides and corners) and name them
- describe 3D shapes (referring to faces, edges, corners and points) and name them
- use prepositions and phrases to describe the location of an item, e.g. on top of, between, below, next to, etc.
- use ordinal numbers to specify the position of an item, e.g. the circle is the fourth item
- understand, interpret and use appropriate words to describe movement, e.g. move three steps forward
- specify the direction of a turn, i.e. left or right
- use a range of vocabulary to describe position, movement and direction

Unit Overview: Geometry – Year 2

National Curriculum Requirements

By the end of the year, the children will be able to:

Properties of shapes

- identify and describe the properties of 2-D shapes, including the number of sides and line symmetry in a vertical line
- identify and describe the properties of 3-D shapes, including the number of edges, vertices and faces
- identify 2-D shapes on the surface of 3-D shapes, e.g., a circle on a cylinder and a triangle on a pyramid
- compare and sort common 2-D and 3-D shapes and everyday objects

Position and direction

- order and arrange combinations of mathematical objects in patterns and sequences
- use mathematical vocabulary to describe position, direction and movement, including movement in a straight line and distinguishing between rotation as a turn and in terms of right angles for quarter, half and three-quarter turns (clockwise and anti-clockwise)

Sentence Stems

I know that this shape is a quadrilateral because _____

I know that this shape is not a quadrilateral because _____

This is a __D shape.

This shape has ____ corners.

This shape has ____ edges.

This shape has ____ faces.

This shape has ____ right angles.

This shape has ____ angles that are not right angles.

This shape is called a _____.

Vocabulary

- shape
- 2D / 3D
- straight line
- curved line
- side
- vertex / vertices
- circle
- semi-circle
- triangle
- quadrilateral
 - rectangle
 - square
- pentagon
- hexagon
- heptagon
- octagon
- nonagon
- edge
- face
- point
- reflection
- symmetry
- forwards
- backwards
- turn
- half
- quarter
- angle
- right angle
- rotation

Manipulatives

- pictures of 2-D shapes
- 3-D shapes (including everyday items)
- maps
- clocks

Visual Representations

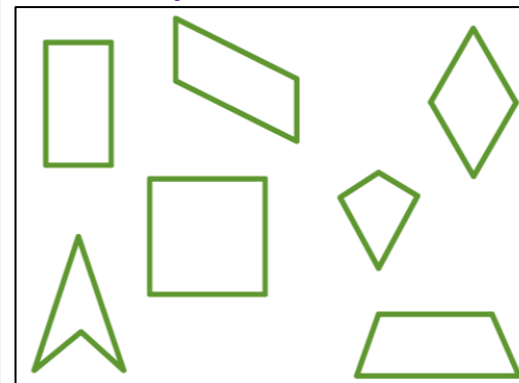

Quadrilaterals

Equal Sides

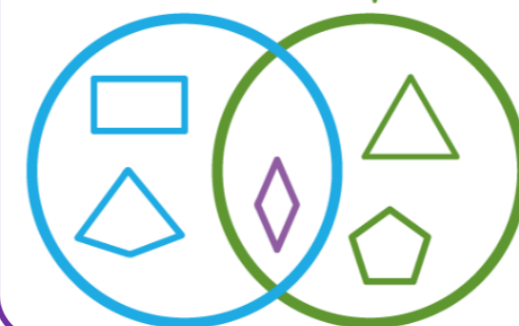

Learning Sequence

- describe 2D shapes (referring to sides and vertices) and name them
- name 2D shapes of up to nine sides
- identify whether a 2D shape or image has a vertical line of symmetry
- sort 2D shapes by their mathematical properties (vertices, sides, vertical line of symmetry) using a Venn Diagram
- describe 3D shapes (referring to edges, vertices and faces) and name them
- identify 2-D shapes on the surface of 3-D shapes, e.g., a circle on a cylinder and a triangle on a pyramid
- know that pyramids are 3D shapes that have triangular faces rising to a point
- know that prisms are 3D shapes with rectangular faces joined by identical ends
- give – and follow – directions of movement in straight lines
- identify where angles exist in diagrams, pictures and the real world
- identify angles that are right angles
- categorise angles that are, and are not, right angles
- associate right angles and measures of turn and describe measures of turn as right angles
- use the words clockwise and anticlockwise to articulate how much of a turn has taken place and the direction of the turn
- order and arrange combinations of mathematical objects in patterns and sequences

Unit Overview: Geometry – Year 3

National Curriculum Requirements

By the end of the year, the children will be able to:

Properties of shapes

- draw 2-D shapes and make 3-D shapes using modelling materials; recognise 3-D shapes in different orientations and describe them
- recognise angles as a property of shape or a description of a turn
- identify right angles, recognise that two right angles make a half-turn, three make three quarters of a turn and four a complete turn; identify whether angles are greater than or less than a right angle
- identify horizontal and vertical lines and pairs of perpendicular and parallel lines

[NB: no new requirements for position and direction in Year 3]

Vocabulary

- degrees
- right angle
- acute angle
- obtuse angle
- horizontal
- vertical
- perpendicular
- parallel
- trapezium
- rhombus
- kite
- cuboid
- hemisphere

Manipulatives

- pictures of 2-D shapes
- 3-D shape nets

Visual Representations

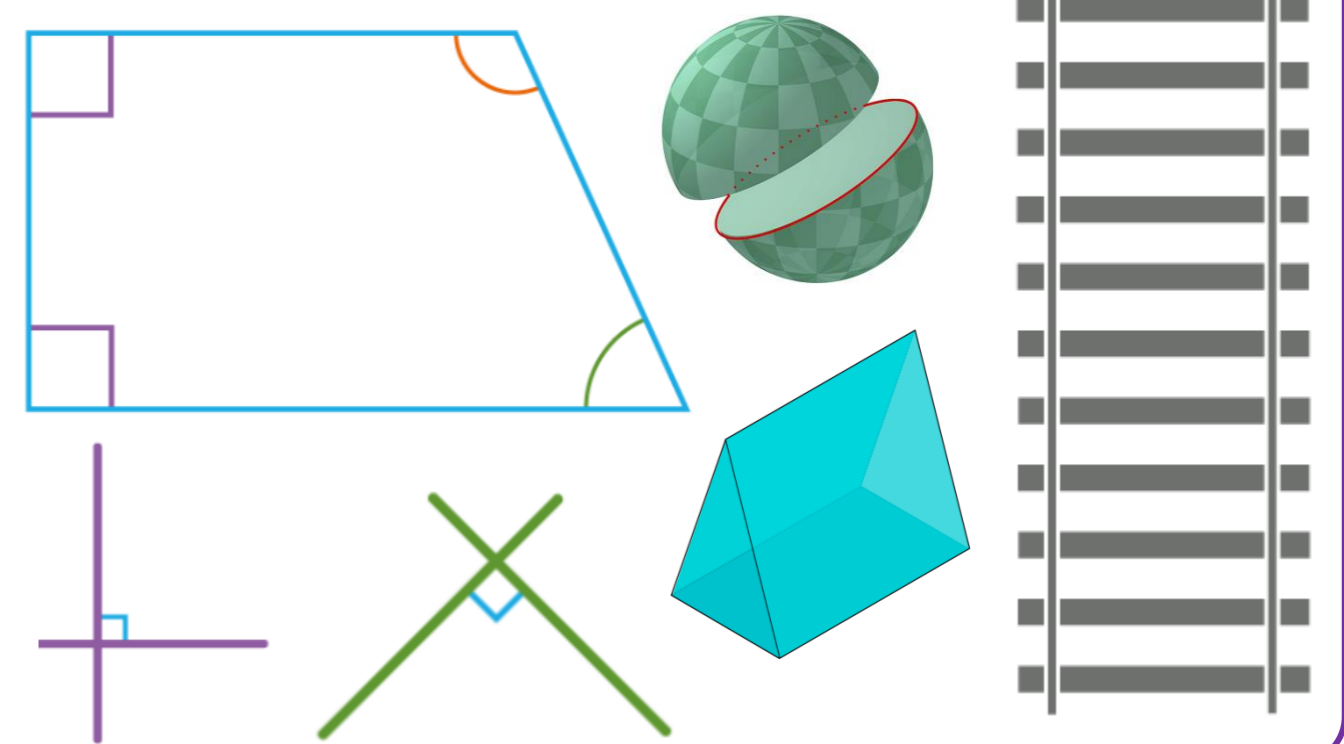

Sentence Stems

This shape has _____ angles.

I know that is a right angle because _____

I know that is an acute angle because _____

I know that is an obtuse angle because _____

This line is a _____ line. I know this because _____

This is a __D shape.

This shape has ____ corners.

This shape has ____ edges.

This shape has ____ faces.

This shape has ____ right angles.

This shape has ____ angles that are not right angles.

This shape is called a _____.

Learning Sequence

- identify where the angles are on a shape and identify how many angles there are
- sort 2D shapes according to their properties, including angles
- identify right angles in diagrams marked with a square or 90°
- know that the word acute means an angle smaller than a right angle
- know that the word obtuse means an angle bigger than a right angle (up to 180°)
- compare given angles to right angles to discover if they are acute or obtuse
- describe turns using right angles and associated language
- identify right angles in a shape
- sort shapes according to their angle types
- identify a horizontal and vertical lines in a variety of situations
- identify perpendicular lines in different situations
- identify parallel lines in different situations including shapes and pictures
- explain the difference between horizontal, vertical, parallel and perpendicular lines
- name and draw common 2D shapes from descriptions of their properties including triangle, square, rectangle, trapezium, rhombus, circle, semi-circle, and kite
- name the common 3D shapes (even when presented in different orientations) including cube, cuboid, prism, pyramid, sphere and hemisphere
- make 3D shapes using different materials

Unit Overview: Geometry – Year 4

National Curriculum Requirements

By the end of the year, the children will be able to:

Properties of shapes

- compare and classify geometric shapes, including quadrilaterals and triangles, based on their properties and sizes
- identify acute and obtuse angles and compare and order angles up to two right angles by size
- identify lines of symmetry in 2-D shapes presented in different orientations
- complete a simple symmetric figure with respect to a specific line of symmetry

Position and direction

- describe positions on a 2-D grid as coordinates in the first quadrant
- describe movements between positions as translations of a given unit to the left/right and up/down
- plot specified points and draw sides to complete a given polygon

Vocabulary

- navigate
- compass
- orientation
- translate
- translation
- co-ordinates
- axis
- compare
- classify
- symmetry

Manipulatives

- mirrors
- compasses
- a variety of shapes

Visual Representations

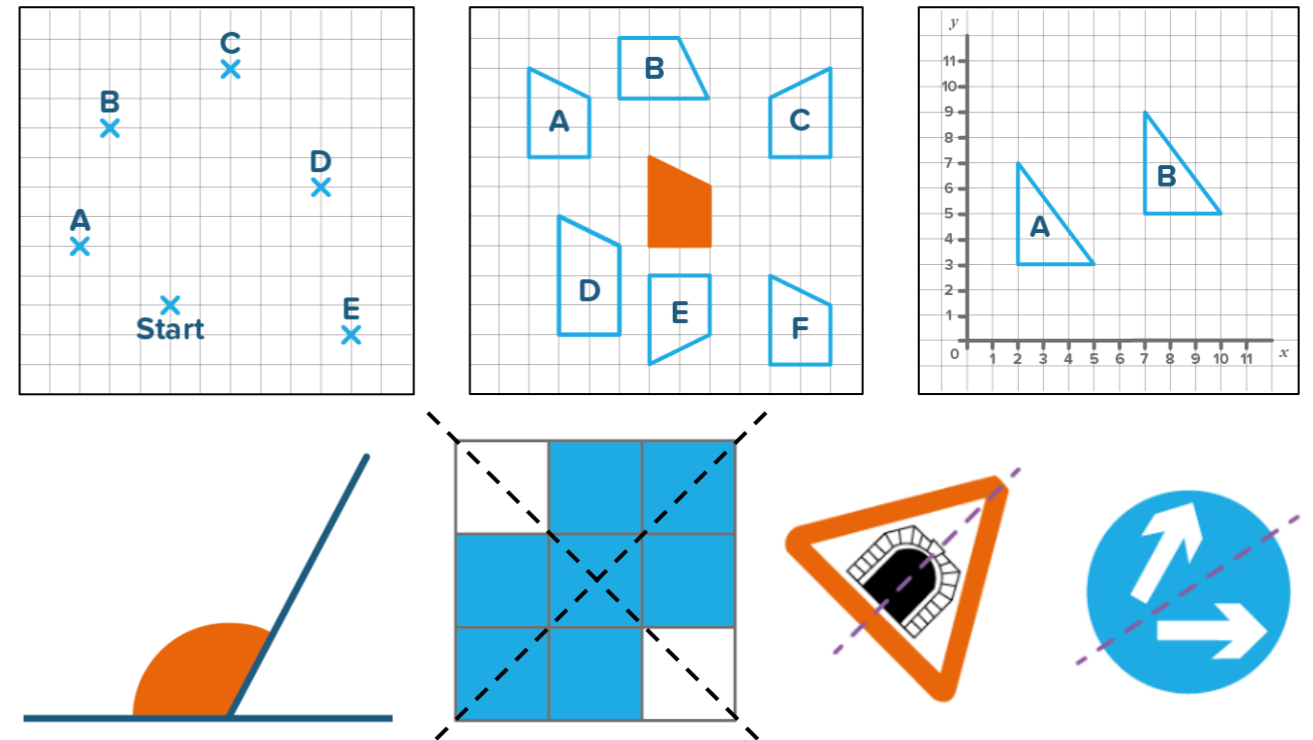

Sentence Stems

From the start position, move _____

The shape has moved ____ squares ____ and ____ squares ____.

The first part of the coordinate means _____; the second part of the coordinate means _____.

I know that is a right angle because _____

I know that is an acute angle because _____

I know that is an obtuse angle because _____

This shape has ____ lines of symmetry.

Learning Sequence

- navigate around a square grid using: commands such as left, right, up and down; commands about turns and parts of turns, clockwise and anticlockwise
- use the four main directions on a compass to navigate around a square grid
- understand that a translation simply moves a shape to another location on the grid, it does not change the size of the shape or the orientation
- translate a shape on a square grid when given instructions to move the shape by a number of squares left or right and up or down
- apply translations to points given as coordinates on a grid
- find the co-ordinates of the corners of a shape on a grid after it has been translated
- describe how an object has moved on a co-ordinate grid using distance, left, right, up and down
- identify angles – including in everyday objects – as being either an acute, obtuse or a right angle
- compare angles to sort a selection into order from smallest to largest
- identify if a shape has zero, one, two, three or four lines of symmetry
- draw the lines of symmetry in any direction on a symmetrical shape
- reflect a pattern in a horizontal, vertical line or diagonal line
- compare and classify geometric shapes, including quadrilaterals and triangles, based on their properties and sizes

Unit Overview: Geometry – Year 5

National Curriculum Requirements

By the end of the year, the children will be able to:

Properties of shapes

- identify 3-D shapes, including cubes and other cuboids, from 2-D representations
- know angles are measured in degrees: estimate and compare acute, obtuse and reflex angles
- draw given angles, and measure them in degrees ($^{\circ}$)
- identify:
 - angles at a point and one whole turn (total 360°)
 - angles at a point on a straight line and $1/2$ a turn (total 180°)
 - other multiples of 90°
- use the properties of rectangles to deduce related facts and find missing lengths and angles
- distinguish between regular and irregular polygons based on reasoning about equal sides and angles

Position and direction

- identify, describe and represent the position of a shape following a reflection or translation, using the appropriate language, and know that the shape has not changed

Vocabulary

- acute
- obtuse
- right
- reflex
- straight line
- full rotation
- polygon
- reflection
- translation

Manipulatives

- protractors
- 3D shape nets
- mirrors

Visual Representations

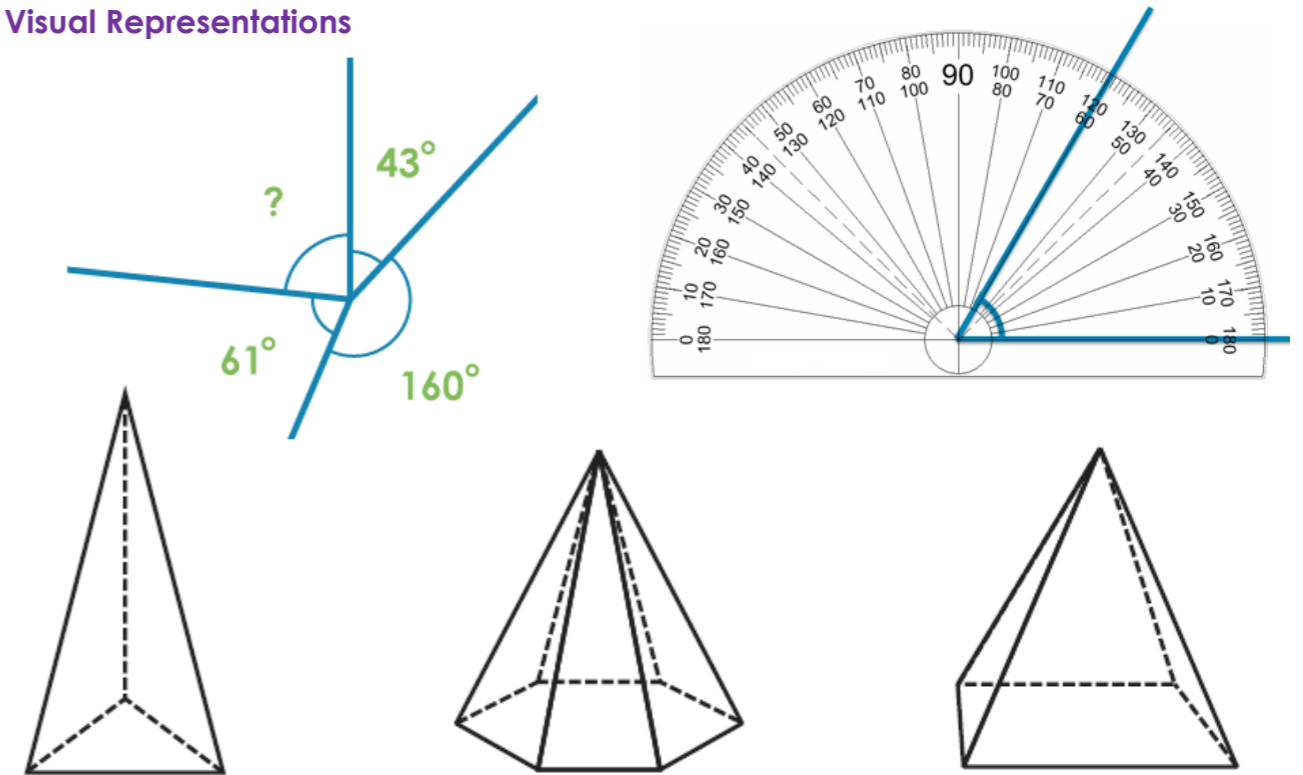

Sentence Stems

I know that is a right angle because _____

I know that is an acute angle because _____

I know that is an obtuse angle because _____

I know that is a reflex angle because _____

A full rotation, or whole turn, is _____ degrees.

A half rotation, or half turn, is _____ degrees.

The shape has moved _____

The first part of the coordinate means _____; the second part of the coordinate means _____.

Learning Sequence

- describe angles using: acute, obtuse, right, reflex, straight line and full rotation
- sensibly estimate the size of angles in diagrams and in 2D shapes using degrees
- compare two or more angles by describing the similarities and differences between them
- accurately read the scale on a protractor, in both directions, and use a protractor to measure the size of angles – stating the size of angles appropriately using the degrees symbol ($^{\circ}$)
- accurately draw angles using a protractor, pencil and ruler
- understand that angles that meet at a point are equal to a full rotation or whole turn: 360°
- understand that angles that meet at a point on a straight line are equal to a half rotation or half of a turn: 180°
- identify angles that make a quarter or three quarters of a turn (multiples of 90°)
- identify, describe and represent the position of a shape following a reflection or translation, using the appropriate language, and know that the shape has not changed
- use the properties of rectangles to deduce related facts and find missing lengths and angles
- define a polygon as a 2D shape with three or more straight sides that is enclosed and recall the names of polygons and classify them by the number of sides that they have
- calculate: the length of one side of a regular polygon given the perimeter; the size of one angle of a regular polygon; the missing angle of an irregular polygon; the sum of the interior angles of a polygon
- identify 3-D shapes, including cubes and other cuboids, from 2-D representations

Unit Overview: Geometry – Year 6

National Curriculum Requirements

By the end of the year, the children will be able to:

Properties of shapes

- draw 2-D shapes using given dimensions and angles
- recognise, describe and build simple 3-D shapes, including making nets
- compare and classify geometric shapes based on their properties and sizes and find unknown angles in any triangles, quadrilaterals, and regular polygons
- illustrate and name parts of circles, including radius, diameter and circumference and know that the diameter is twice the radius
- recognise angles where they meet at a point, are on a straight line, or are vertically opposite, and find missing angles

Position and direction

- describe positions on the full coordinate grid (all four quadrants)
- draw and translate simple shapes on the coordinate plane, and reflect them in the axes

Vocabulary

- acute
- obtuse
- right
- reflex
- straight line
- full rotation
- polygon
- reflection
- translation
- equilateral triangle
- isosceles triangle
- scalene triangle
- radius
- diameter
- nets
- properties

Visual Representations

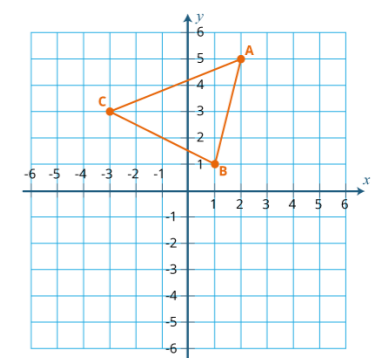
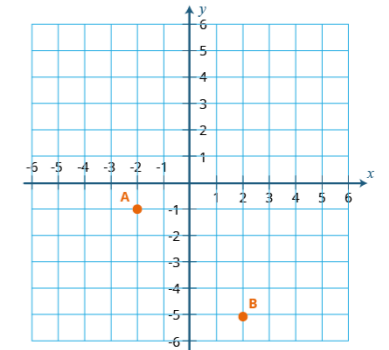
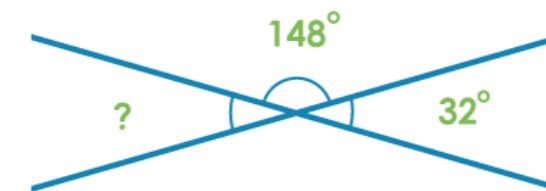
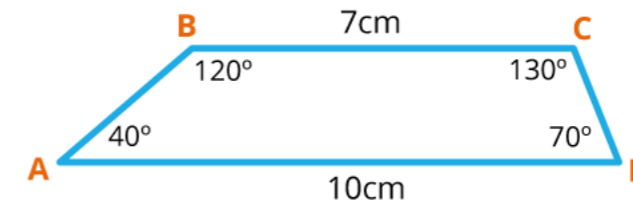
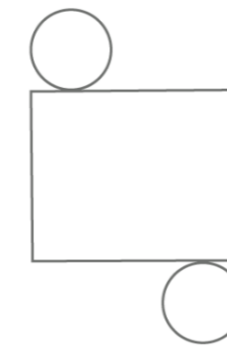
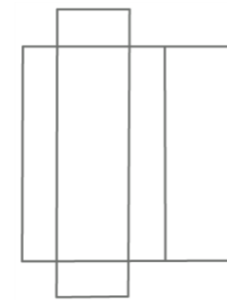

Sentence Stems

I know that is a right angle because _____

I know that is an acute angle because _____

I know that is an obtuse angle because _____

I know that is a reflex angle because _____

The differences between these two shapes are _____

The similarities between these two shapes are _____

The radius is _____; to calculate the radius _____

The diameter is _____; to calculate the diameter _____

This is the net for a _____

Learning Sequence

- read and plot points on a co-ordinate grid (all four quadrants)
- draw reflections of shapes plotted on a co-ordinate grid, using the axes as mirror lines
- draw and translate simple shapes drawn on a full coordinate grid
- construct polygons, using a ruler and a protractor, when given the lengths of the edges and the angles
- identify different types of triangles and calculate missing angles using the angle sum and triangle properties
- construct triangles – of varying type – based on given measurements
- calculate missing angles – on a straight line, around a point and within a quadrilateral
- recognise and identify pairs of vertically opposite angles
- name polygons and use mathematical terminology to describe them
- find the interior angle sum of polygons and calculate the exterior angles of regular polygons (with the knowledge that exterior angles of regular polygons equal 360 degrees)
- understand how radius and diameter are related and can be calculated using multiplication and division ($R = D \div 2$; $D = R \times 2$)
- recognise and use the properties of 3D shapes
- describe what nets are and what they do; identify and draw nets for 3-D shapes
- identify and draw front, rear and side view elevations of 3-D figures